

Vertical Force Test Stand

FGS-100E-H/L

Operation Manual



Please read carefully before using this product.

Read carefully "Safety Precautions" and Handling Instructions.

Use appropriately as directed.

Before Installation, Operation or Maintenance, be sure to read carefully this Operation Manual and use the equipment as directed. Use the equipment after carefully reading all the caution items, safety information, and other discriminations. In this User's Manual, the Safety Awareness Items are divided into three different categories: "Danger", "Warning" and "Caution".



DANGER

This symbol indicates if you ignore the contents mentioned and improperly operate, it may lead to serious injury from a potential fire.



WARNING

This symbol indicates a potential dangerous situation that could produce a serious injury if improperly handled.



CAUTION

This symbol indicates a potential situation that could produce a minor injury or damage to material if it is improperly handled. However, depending upon the situation, there could be a possibility that it may cause more serious results.

Protection categories are explained and separated by the following symbols.



Proceed with Caution



Not Allowed –Prohibited



Mandatory– Must Follow



WARNING



Heavy! Take sufficient care while handling. Ensure stand is placed on a flat, level, stable surface that can support the unit.



Do not operate in areas where explosive gases or vapors may be present.









Do not touch the running, inner parts. Keep appendages and loose clothing away from running, moving parts.



Do not attempt to inspect or perform maintenance on the unit with the electrical cord connected to a power source.



CAUTION

| | |
|--|--|
|  <p>If a loud noise is created from the unit during operation, check the mounting of the gauge or level of the stand. If noise persists, contact the factory.</p> |  <p>Do not install in a high humidity environment or near where water may be present. Electric shock may occur if water is encountered.</p> |
|  <p>Hold power plug while removing the power cord. Do not pull or put tension on the cord. Doing so could result in cord damage and electric shock.</p> |  <p>Do not scratch, damage, cut, over-turn, pull, twist, or bundle the power supply cord. The electric power cord may be broken and may cause electric shock, fire or accident.</p> |
|  <p>Use only matching electrical sockets. Do not alter the power connector in order to fit an unmatched socket. Shock or fire could result.</p> |  <p>Confirm that the power supply is the same voltage rating as the displayed voltage rating on the unit.</p> |



Mandatory

| | |
|---|--|
| <ul style="list-style-type: none"> ● Do Not Use in Below Mentioned Locations. <ol style="list-style-type: none"> ① Where water, oil or chemicals may come in contact. ② Where there is ample amounts of dust. ③ Where condensation may emerge. ④ Where a fire or explosion may exist or occur. ⑤ Where vibration of machinery exists. ⑥ Where temperatures will go outside of 32 °F to 104 °F (0°C to 40°C). ● Do not clean with flammable liquids such as thinner and gasoline. | <ul style="list-style-type: none"> ● Take care that the Force Gauge Cable is not caught in the moving parts. This can be prevented by properly securing the cable so that it cannot come into contact with the moving parts. ● Mount the Force Gauge to the Test Stand with the Test Stand's power switch in the off position. ● Do Not adjust the limit knobs while the Test Stand is moving. ● Ensure that the green earth grounding wire of the power cord is grounded. |
|---|--|

Installation of Digital Force Gauge FGV Series

While installing the Digital Force Gauge FGV Series to the Test Stand FGV Function Setting F06 Outer Parts Output Switchover Setting is to be performed by the Over Load Output (over) Setting. If setting is performed using the Comparator Output, then with the Force Gauge Over Load (Excess Load), the Stand does not Stop.

Index

- 1. Before Use 4
 - 1.1. Force Gauge Installation 4
 - 1.2. Inspection of Included Accessories 4
- 2. Specification 5
- 3. Product Diagram 6
- 4. Operation Panel Functions. 6
- 5. Preparation 8
 - 5.1. Installation of Force Gauge. 8
 - 5.2. Cable connection to the Force Gauge. 8
- 6. Operation. 9
 - 6.1. Basic Movement 9
 - 6.2. Speed unit change 10
 - 6.3. Changing Mode 11
 - 6.4. Movement Mode 11
 - 6.4.1 Jogging Mode. (JOg) 12
 - 6.4.2 Manual Mode. (MAU) 12
 - 6.4.3 1 Cycle Mode. (Sig) 13
 - 6.4.4 Continue Mode. (CON) 14
 - 6.5. Speed 15
- 7. Display Error 16
- 8. Outer Dimensions. 17
- 9. Trouble Shooting. 18

1. Before Use

1.1. Force Gauge Installation

This Shimpo Instruments FGS-100E Test Stand is to be installed with a Shimpo Instruments Digital Force Gauge Series FGV and is able to perform all types of Load Tests. Related to its execution from installation to measurement, utilize the following procedure. If encountering issues, check the Trouble Shooting section of this manual.

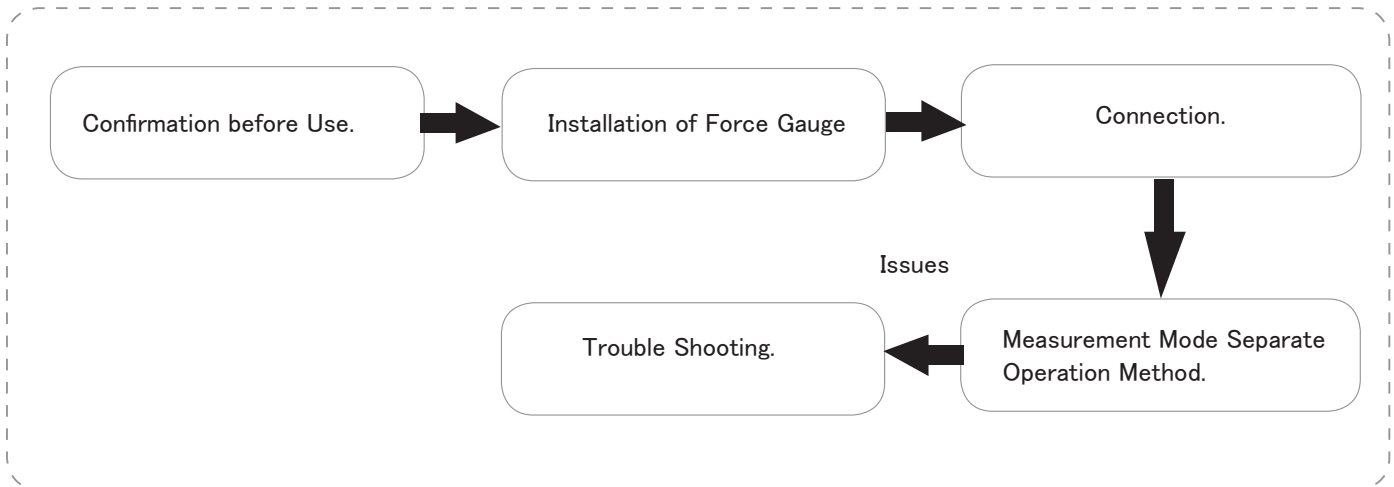

1.2. Inspection of Included Accessories

| Name of Product. | Quantity. |
|--|-----------|
| FGV Connecting Cable (2m). | 1 |
| Power Supply Cable | 1 |
| Cable Clip | 1 |
| Socket Bolt (M4 x 8) for Installing Gauge to Sta | 4 |
| Socket Bolt (M6 x 12) for Test Jig Installation. | 2 |
| Allen Key Spanner for M6t. | 1 |
| Allen Key Spanner for M4 | 1 |
| Operation Manual | 1 |
| Guarantee | 1 |

2. Specifications

| Series | | FGS-100E | |
|---------------------------|----------------|---|--------------------------------|
| Model | | FGS-100E-L | FGS-100E-H |
| | | Low Speed Specifications | High Speed Specifications |
| Measuring Load | | 500N(50kgf) (112.4 lbf) | |
| Load Resistance | | 500N(50kgf) (112.4 lbf) | |
| Forwarding Speed | | 6-180mm/min(0.23-7.00in/min) | 20-600mm/min(0.78-23.60in/min) |
| Speed Settings | | Set the Speed through Operation panel. | |
| Speed Accuracy | | ± 5% | |
| Stroke | | 400mm (15.75in) | |
| Display Parts | | LCD 3 Digits indicates movement speed, Operation Mode. | |
| Display | Movement Speed | 6-180mm/min(0.23-7.00in/min) | 20-600mm/min(0.78-23.60in/min) |
| | Operation Mode | Manual (MAU), Jogging (JOG), 1 Cycle (SIG), Continuous (CON). | |
| Input | | Over Load Input Stops by FGV Over Load Signal | |
| Measurement Table | | 93 × 150mm(3.66 × 5.91in) | |
| Temperature Range | | 0 ~ 45° (No Condensation) 32 to 113° F | |
| Power Supply | | AC100 ~ 230V ± 10% | |
| Weight | | Approx.20kg(40.1lbs) | |
| Outer Dimensions | | 220 × 680 × 358mm (8.7 × 26.8 × 14.1in) | |
| Corresponding Force Gauge | | FGE-0.5 ~ 100 FGV-0.5 ~ 100 | |

3. Product Diagram

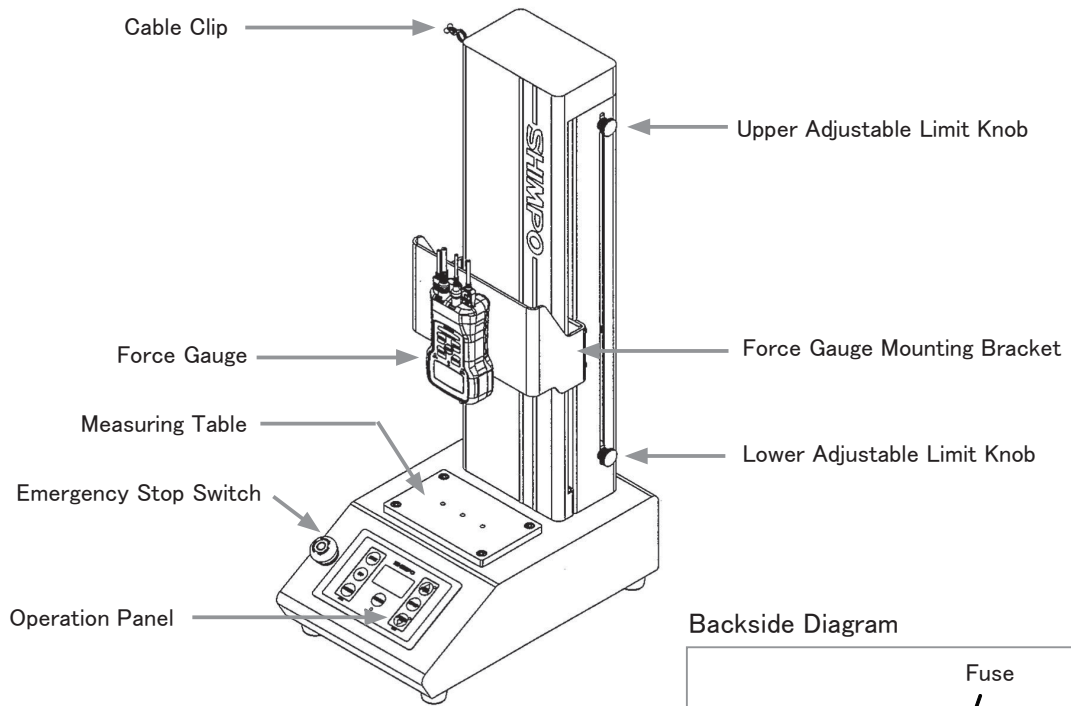

Backside Diagram

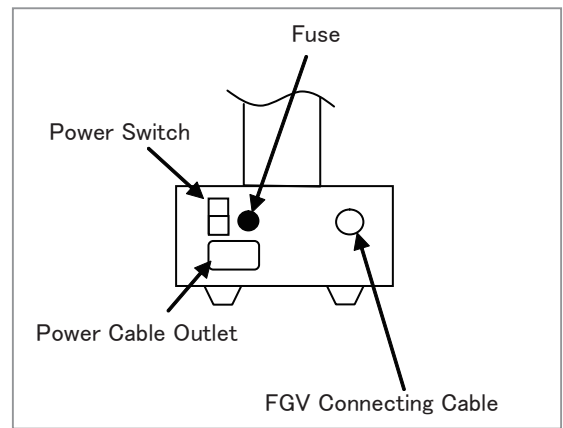

4. Operation Panel Functions

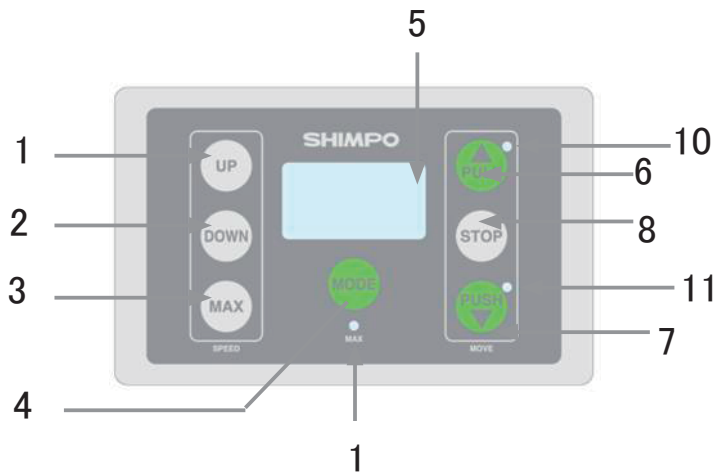

| No. | Names | Function |
|-----|----------|--|
| 1 | UP | Set Movement Speeds for Manual (MAU), JOGGING (JOg) Modes and during PUSH/PULL Operation in 1 Cycle (Sig) and Continuous (CON) Modes. inch/min Mode : Pressed once , the movement speed increases/decreases by 0.01 if pressed continuously , it changes at the rate of 0.1 . |
| 2 | DOWN | mm/min Mode : Pressed once , the movement speed increases/decreases by 1 ,if pressed continuously , it changes at the rate of 10 . |
| 3 | MAX | Overrides to the maximum speed value possible of the Stand's motor when pressed. Once released, the speed returns to the previous set value. |
| 4 | MODE | Scroll through the Modes (MAU) |
| 5 | LCD | Displays the condition of Movement Speed, Mode, Alarms. Etc. |
| 6 | PULL | Starts the Operation of PULL Direction |
| 7 | PUSH | Starts the Operation of PUSH Direction |
| 8 | STOP | Stops Test Operation |
| 9 | MAX_LED | Pressing MAX Key, when the Movement Speed is at Maximum, the Lamp lights. |
| 10 | PULL_LED | During PULL Operation it flashes |
| 11 | PUSH_LED | During PUSH Operation it flashes |

LCD Normal Display

1) Sub Display Parts:

Presently selected Operation Mode is displayed at the top Sub-Display of LCD.

Limit Position, Over Load condition, or when the Emergency Stop is ON, the Operation Mode and all the Indicators light-up alternately.

- ① Limit Position Reached in Operation Mode LMT Flashes
- ② Over Load Occurrence in Operation Mode OVR Flashes
- ③ When Emergency Stop is ON in Operation Mode EMg Flashes

2) Main Display Parts:

The set movement speed value is indicated in the main display.

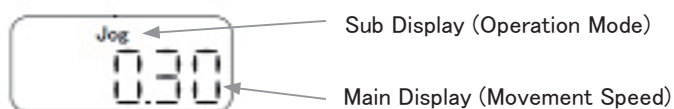

5. Preparation

5.1. Installation of Force Gauge

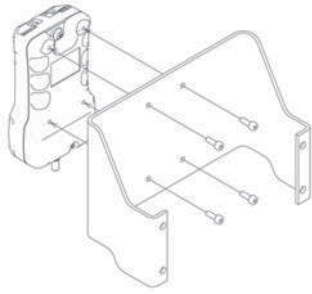

Using the Allen wrench spanner provided in the accessories, remove the installation bolts connecting the Test Stand and the Force Gauge Mounting Bracket



Attach the Force Gauge to the Force Gauge Mounting Bracket.



With Installation Bolts, secure to the bracket.

※ Attach the Force Gauge to the Mounting Bracket.

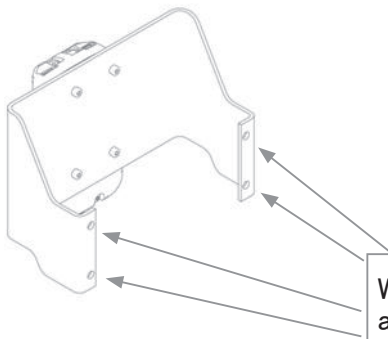

With the 4 Installation bolts, install the Force Gauge and Mounting Bracket to the Test Stand



Possible Force Gauges to install on the FGS-100E is the FGV Series Force Gauges

5.2. Cable connection to the Force Gauge.

Insert the attached connecting cable to the back-side connector of FGS-100E Stand and connect the other side to the corresponding connector of Force Gauge.

If this communication cable is not connected, the automatic stop function of the Stand due to a Force Gauge sensor over load condition may not be available. In order to protect the Force Gauge, ensure proper connection.

6. Movement

6.1. Basic Movement



Take sufficient care while aligning, as there is potential of catching a hand, finger or clothes in the Stand which would cause injury.

Test Stand Power Cord is connected to outlet as well as Force Gauge power Adapter. Turn on Force Gauge.

Test Stand Power Cord is connected to outlet as well as Force Gauge power Adapter. Turn on Force Gauge.

Once on, the display will indicate the model number, then will show the speed setting as shown below.



(Example) Tension Test of Wire.

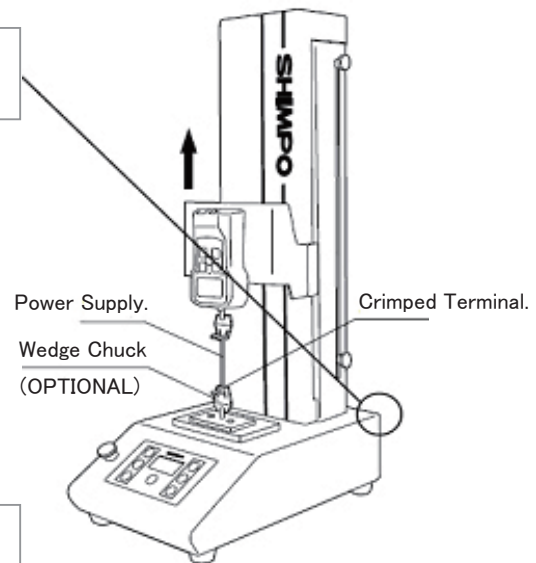

MODE (Measuring Method) Setting.

Select the Movement Mode, matching to your required test needs.

Movement Mode

Press the PUSH Key or PULL Key to cycle through Manual, Jogging, 1 Cycle or Continuous movement.

Manual Mode Display.

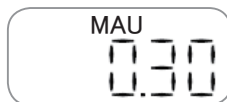

Jogging Mode Display.

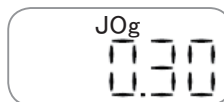

1 Cycle Mode Display.

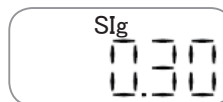

Continuous Mode Display.

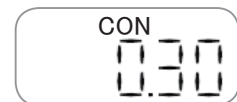

Start Measuring

With the PUSH or PULL Key, Measurement can be started.
For details refer to the Movement Mode Operation described later. Load Tests as follows can be performed.

Press Test – Tensile Strength Test – Weld Strength Test – Peel off Test – Absorption Power Test
Resistance Power Test – Uncapping (Seal) Test – Punching Test.

6.2. Speed unit change

① When changing the operation speed to inch/mm from mm/min

a) Power OFF

Turn ON the stand while holding down the “MAX” key.
Keep pressing the “MAX” key until the display shows JOG mode

b) After the stands turn ON, the display shows its model name

*Still keep pressing “MAX” key at this point

c) To JOg mode

Then, the stand goes to JOg mode.
The stand shows default value of operation speed.
Low speed : 0.30inch/min
High speed : 0.80inch/min
Then, the unit change is finished.

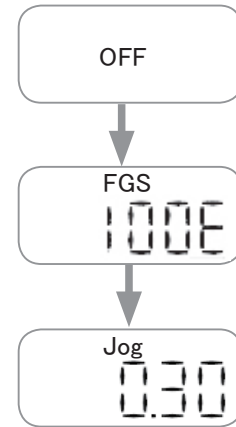

② When changing the operation speed to mm/min from inch/mm

a) Power OFF

Turn ON the stand while holding down the “MAX” key.
Keep pressing the “MAX” key until the display shows JOG mode

b) After the stands turn ON, the display shows its model name

*Still keep pressing “MAX” key at this point

c) To JOg mode

The stand goes to JOg mode and shows default of operation speed.
Low speed : 6mm/min
High speed : 20mm/min
The unit change is finished

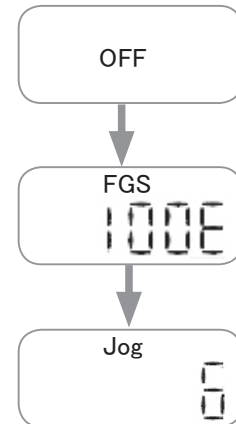

6.3. Changing Mode

To perform a load test manually, press the PUSH or PULL key.

Examples.

- Press the PULL Key once, if you want to move the Force Gauge up to the top Limit Knob
- Press the PUSH Key once, if you want to make move the Force Gauge down to the bottom Limit

If the Mode Selection Switch (Operation Panel) is pressed, the Movement Mode changes by turns as follows. Utilize by selecting the Movement making Mode. The present Movement Mode is displayed at the upper centre of LCD.

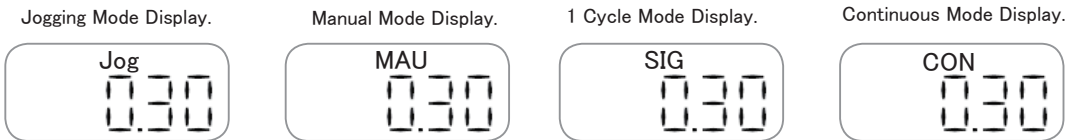
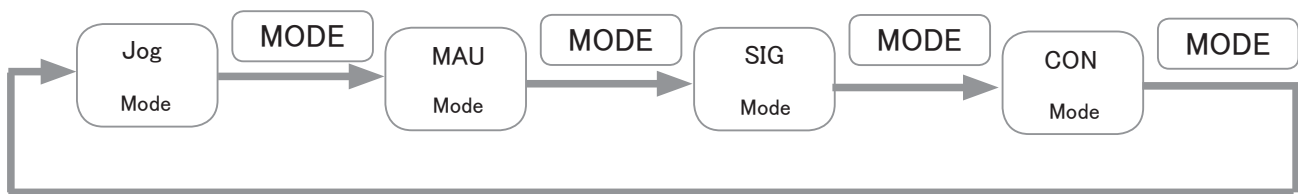

6.4. Movement Mode

Select out of 4 varieties of Movements

| | |
|--------------------------------|--|
| Manual Mode MAU | Press the PUSH or PULL Key once, the Stand proceeds at the preset speed until hitting the Upper or Lower Adjustable Limit Knobs or if the STOP button is pressed. |
| Jogging Mode JOg | Stand moves as long as PUSH or PULL key remain pressed. |
| 1 Cycle Mode SIg | Press the PUSH or PULL key once. The Stand will proceed towards the Limit Knob in the PUSH/PULL direction. It will hit that Limit, then move in the opposite direction all the way to the opposing Limit Knob. |
| Continuous Mode CON | Press the PUSH or PULL key once. The Stand will cycle between the Limits continuously until the STOP key is pressed. |

6.4.1 Jogging Mode (JOg)

Jogging Movement is performed

While the PUSH Key or PULL Key is pressed, it moves towards PUSH (downward) or PULL (upward). If you release the PUSH Key or PULL Key the movement stops.

The speed changes by UP or DOWN Key. The speed setting of JOg Mode and MAU Mode become common. Speed Variation is also possible during the movement while PUSH/PULL are depressed.

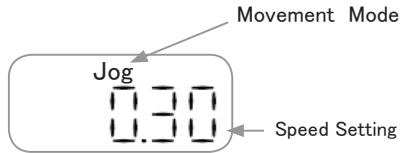

6.4.2. Manual Mode (MAU)

If the PUSH Key or PULL Key is pressed once, it moves downward (PUSH) or upward (PULL). When the Limit Knob is reached, it stops. The STOP key can at any time stop the process.

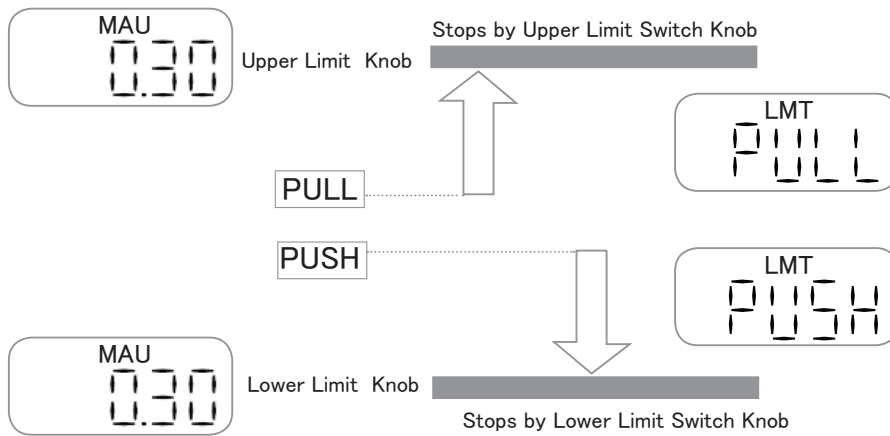

Change speed by UP, DOWN Key. The speed setting of JOG Mode and MANU Mode becomes common. Speed Variation is also possible during the movement.

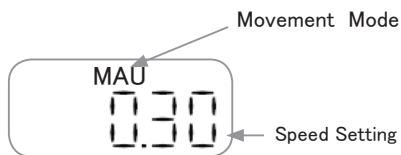

6.4.3 1 Cycle Mode (Sig)

Contents

1 Cycle (Compression. Expansion) Movement is performed.

Between the Limits, the stand repeats movement for 1 time cycle only. The Stand will proceed towards the Limit Knob in the PUSH/PULL direction. It will hit that Limit, then move in the opposite direction all the way to the opposing Limit Knob.

If either PUSH Key or PULL Key is pressed, the stand starts moving toward that respective direction. STOP key can instantly end the test.

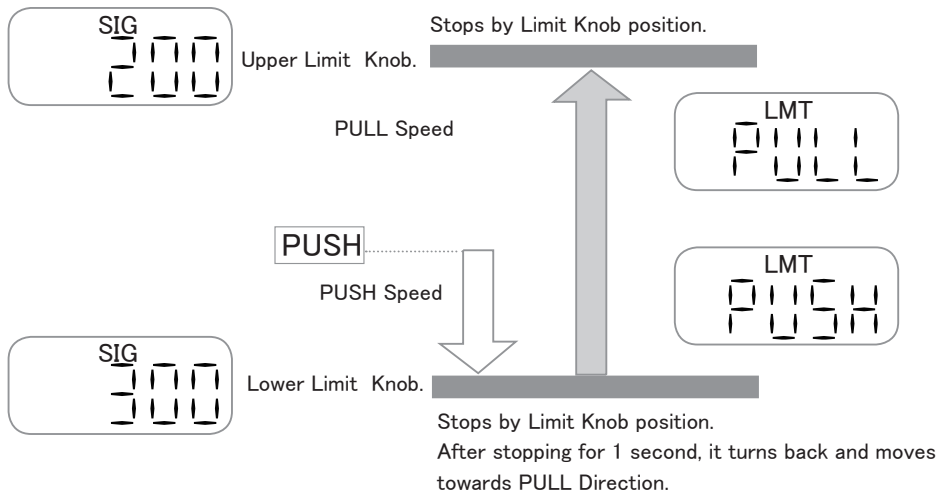
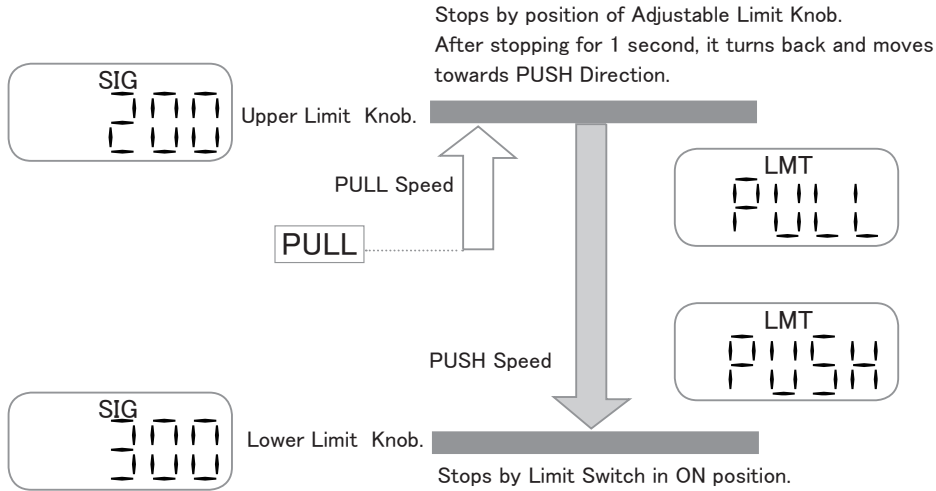

Change speed by UP, DOWN Key. SIG Mode and CON Mode Speed Setting are commonly used. During movement, Speed variation is not possible. When no movement is occurring (at idle), the display shows movement Mode and the latest operated speed. When the movement starts, the respective memorized movement speed is displayed.

6.4.4 Continuous Mode (CON)

Stand performs the continuous repeated movement in between the Adjustable Limit Knobs.

When the PUSH Key or PULL Key is pressed, the stand moves towards that respective direction, hits the knob, then continues on in the opposite direction. This process will continue and cycle until the STOP Key is pressed.

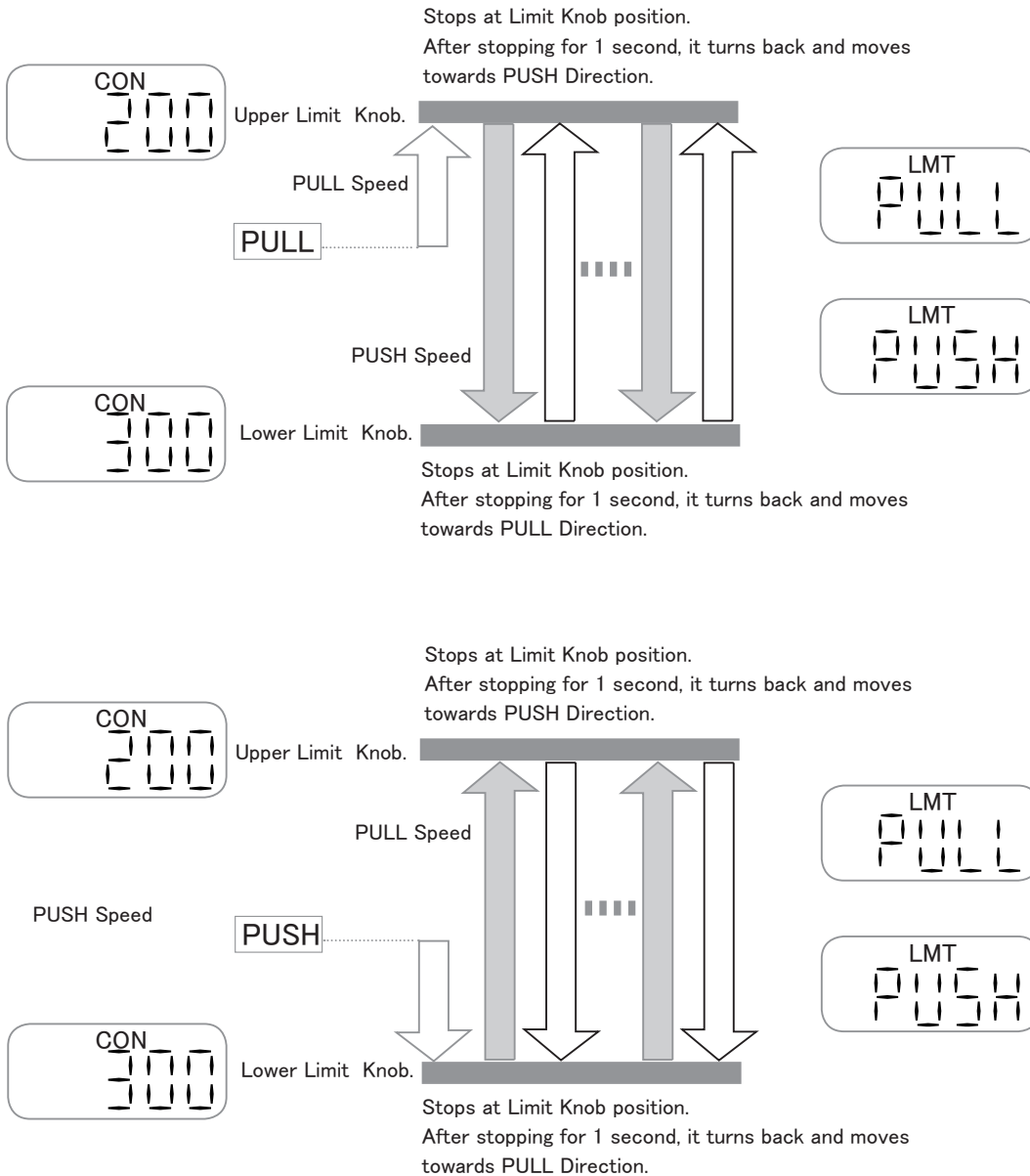

Change speed by UP, DOWN Key. Sig Mode and CON Mode Speed Setting are commonly used. During movement, speed variation is not possible. When no movement is occurring (at idle), the display shows movement Mode and the latest operated speed. When the movement starts, the respective memorized movement . Speed is displayed.

6.5 Speed Setting

The Movement Mode becomes either 1Cycle Mode (Sig) or Continuous Mode (CON) and during the Stop Movement, while pressing the MAX Key, it enters/turns into the Speed Setting.

Setting the PUSH Direction Movement Speed by UP/DOWN Key, if the MAX is pressed, it turns into the PULL Direction Movement Speed Setting.

Setting with the UP/DOWN Key, if the MAX is pressed, then the two-way movement speed is memorized.

In case the setting is to be cancelled during adjustments, press the STOP Key and it will be cancelled.

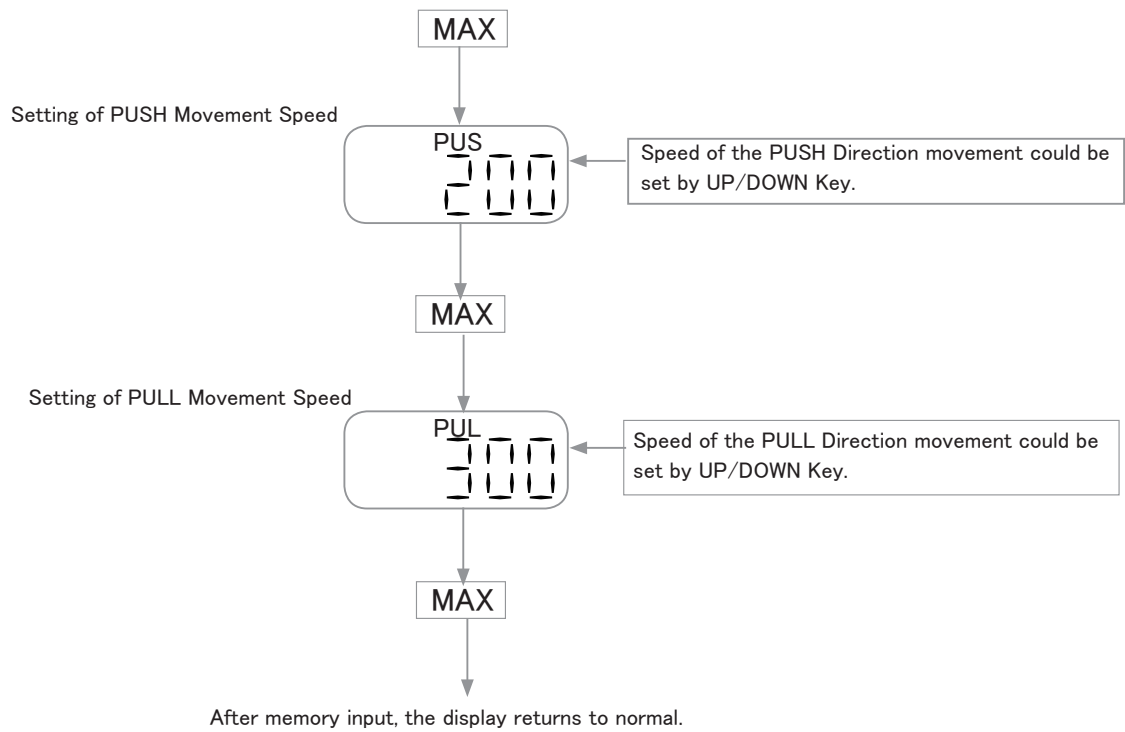

7. Display Error

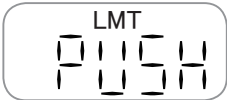
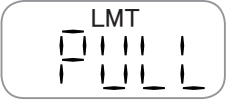
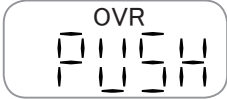
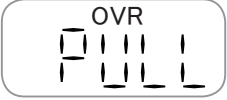
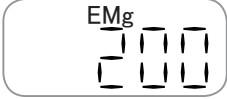
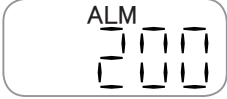
| | | |
|---|---|---|
|  <p>The display shows 'LMT' in the upper left and 'PUSH' in the main display area.</p> | <p>Lower Limit Knob is reached. Upper Display, LMT and MODE flash alternately. Main Display becomes PUSH.</p> | <p>In normal Limit movement, this Display is generated.</p> |
|  <p>The display shows 'LMT' in the upper left and 'PULL' in the main display area.</p> | <p>Upper Limit Knob is reached. Upper Display, LMT and MODE flash alternately. Main Display becomes PULL.</p> | <p>In normal Limit movement, this Display is generated.</p> |
|  <p>The display shows 'OVR' in the upper left and 'PUSH' in the main display area.</p> | <p>The Force Gauge's sensor PUSH over load was detected. Upper Display alternately lights-up with OVR and MODE.</p> | <p>Release opens the movement and load. Confirm the load given to the Force Gauge and confirm whether the rated capacity of the installed Force Gauge is appropriate.</p> |
|  <p>The display shows 'OVR' in the upper left and 'PULL' in the main display area.</p> | <p>The Force Gauge's sensor PULL over load was detected. Upper Display alternately lights-up with OVR and MODE.</p> | <p>Release opens the movement and load. Confirm the load given to the Force Gauge and confirm whether the rated capacity of the installed Force Gauge is appropriate.</p> |
|  <p>The display shows 'EMg' in the upper left and '200' in the main display area.</p> | <p>Emergency Stop Switch was pressed. Upper display alternately lights-up with EMG and MODE.</p> | <p>After avoiding the abnormal condition, put the Emergency Stop Switch to OFF.</p> |
|  <p>The display shows 'ALM' in the upper left and '200' in the main display area.</p> | <p>A motor abnormality was generated. Upper display flashes ALM.</p> | <p>Switch the Power Supply OFF for 1 minute, then turn ON. If again the same Error is generated, then enquire with your local agent or contact our customer service.</p> |

8. Outer Dimensions

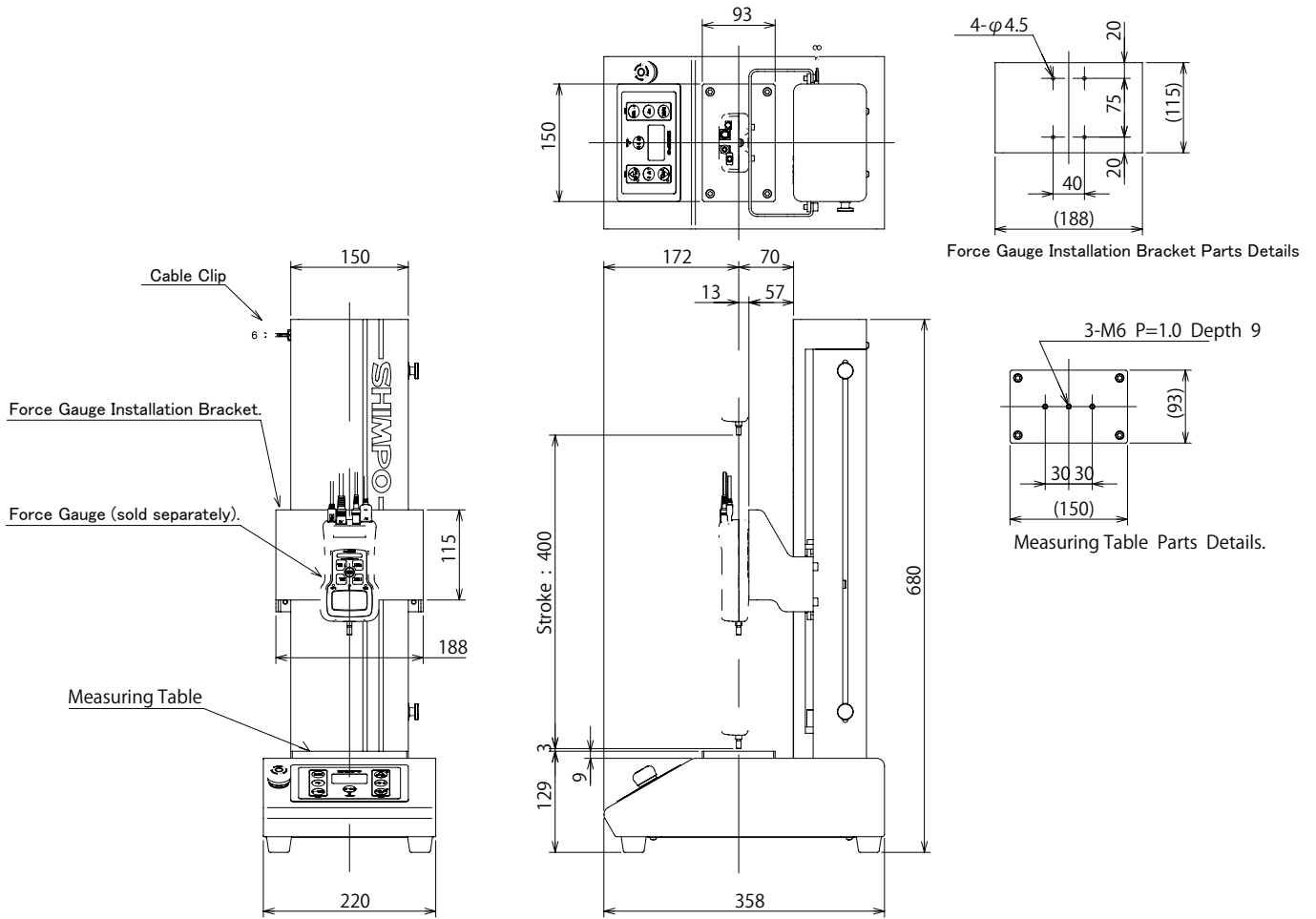

9. Trouble Shooting

Following is the explanation of the examples of general troubles and respective solutions. If you still have issues, then please enquire with your local agent or contact our customer service.

| Phenomenon. | Trouble Solution Method. | |
|---|---|--|
| Even though Power Supply is ON, the LCD does not display. | Confirm whether AC100~240V Power Supply is provided to the Power Supply Cord. → Supply AC100 ~ 240 V | |
| | Confirm whether the Stand Back Side Fuse is interrupted. → In case it is interrupted, confirm whether any abnormalities exist in the Power Supply, replace the Fuse. For Fuse Replacement, use FGMB 250V 5A PBF Fuji Terminal (Appropriate goods) | |
| Arm / Alarm do not work. | | |
| | "ALM" lights up at LCD Display. Motor Alarm | Confirm whether excessive load exists. → Remove Stand Load |
| | "EMg" lights up at LCD Display. (Emergency Stop Switch ON) | Confirm whether Emergency Stop Switch is ON. → After confirming that there is no abnormal condition and confirming that there is no problem, then put the Emergency Stop Switch to OFF. |
| | "OVR" lights up at LCD Display. (Overload detection) | Confirm the Over Load of Force Gauge. → Remove the excessive load of Force Gauge. |
| | "LMT" lights up at LCD Display. (Upper or Lower Limit knob detection). | Reaches to Limit Switch. → Change the position of Limit Switch. |

The Guarantee Card of this product is attached with the product. For contents of the Guarantee, please see the back of Guarantee Card.

NIDEC-SHIMPO AMERICA CORPORATION

1701 Glenlake Avenue Itasca , IL 60143 Phone: (800)237-7079 Fax:(630)924-0342